

ALU ANLEHN-GEWÄCHSHAUS „ANTWERPEN“

ARTIKEL-NR. 47086



**LESEN SIE DIE BEDIENUNGSANLEITUNG UND DIE SICHERHEITSHINWEISE
VOR DER ERSTEN VERWENDUNG GRÜNDLICH DURCH!**

**DEMA-VERTRIEBS GMBH • IM TOBEL 4 • 74547 ÜBRIGSHAUSEN
WWW.DEMA-VERTRIEB.COM**

© DEMA VERTRIEBS-GMBH

Inhaltsverzeichnis

1 SICHERHEITSHINWEISE.....	3
1-1 Bestimmungsgemäße Verwendung	3
2 TECHNISCHE DATEN.....	3
3 ÜBERSICHT.....	4
4 MONTAGE & AUFBAU	5
5 TEILELISTE	15
5-1 PC-Glasscheiben	17

1 SICHERHEITSHINWEISE

- Änderungen die dem technischen Fortschritt dienen, können ohne Vorankündigung vom Hersteller getätigt werden und sind eventuell in der Bedienungsanleitung noch nicht berücksichtigt.
- Kontrollieren Sie das Gewächshaus vor dem Aufbau auf Vollständigkeit und Funktion!
- Nehmen Sie niemals ein defektes oder beschädigtes Gewächshaus in Betrieb! Kontaktieren Sie den Hersteller oder lassen Sie das Gerät von einem qualifizierten Mechaniker kontrollieren.
- Arbeiten Sie immer mit Bedacht und der nötigen Vorsicht!
- Wenden Sie auf keinen Fall übermäßige Gewalt an!
- Halten Sie Kinder und unbeteiligte Dritte vom Arbeitsbereich fern.
- Klettern Sie sich niemals auf das Gewächshaus!
- Montieren Sie das Gewächshaus mindestens zu zweit!
- Tragen Sie bei der Montage des Gewächshauses einen Handschutz um möglichen Schnitten vorzubeugen.
- Verwahren Sie Verpackungsteile (Folien, Plastikbeutel, Styropor, etc.) nur an Orten auf, die Kindern insbesondere Säuglingen nicht zugänglich sind! Da Verpackungsteile oft nicht erkennbare Gefahren bergen (z. B. Erstickungsgefahr).

1-1 BESTIMMUNGSGEMÄßE VERWENDUNG

- Das Gewächshaus eignet sich zum geschützten und kontrollierten Kultivieren von Pflanzen.
- Das Gewächshaus eignet sich nicht als Wohnstätte!

2 TECHNISCHE DATEN

Material Rahmen	Aluminium
Material Glasscheiben	Polycarbonat (PC)
Maße	ca. 126 x 190 x 206 cm
Gewicht	ca. 14 kg

3 ÜBERSICHT

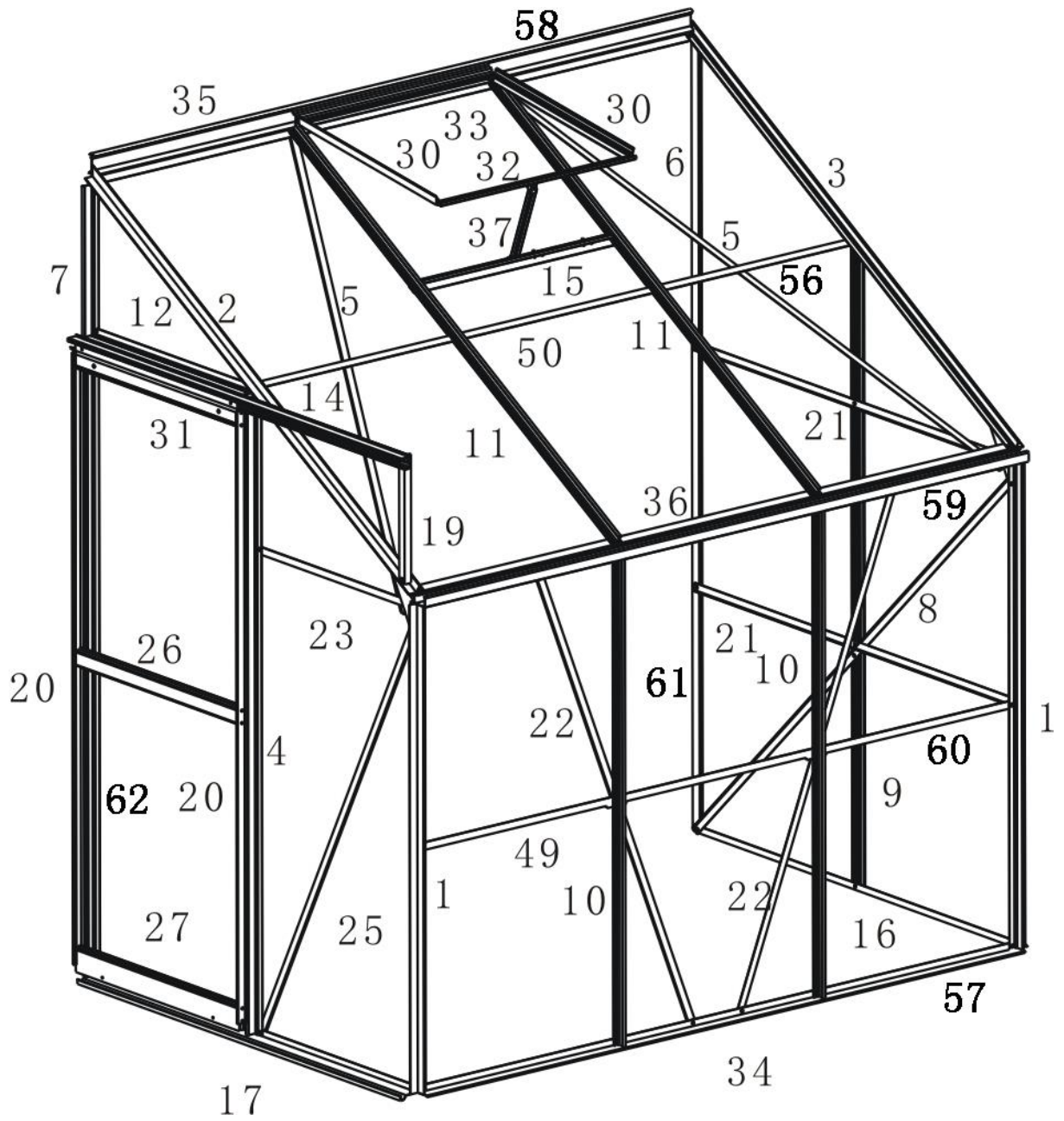

4 MONTAGE & AUFBAU

- Ziehen Sie für die Montage mindestens eine weitere Person als Hilfe hinzu.
- Für die Montage benötigen Sie einen Schraubenschlüssel und Schraubendreher (nicht im Lieferumfang).
- Prüfen Sie vor dem Zusammenbau, ob alle Teile vorhanden sind.
- Folgen Sie den nachfolgenden Aufbauhilfen um das Gewächshaus aufzubauen.

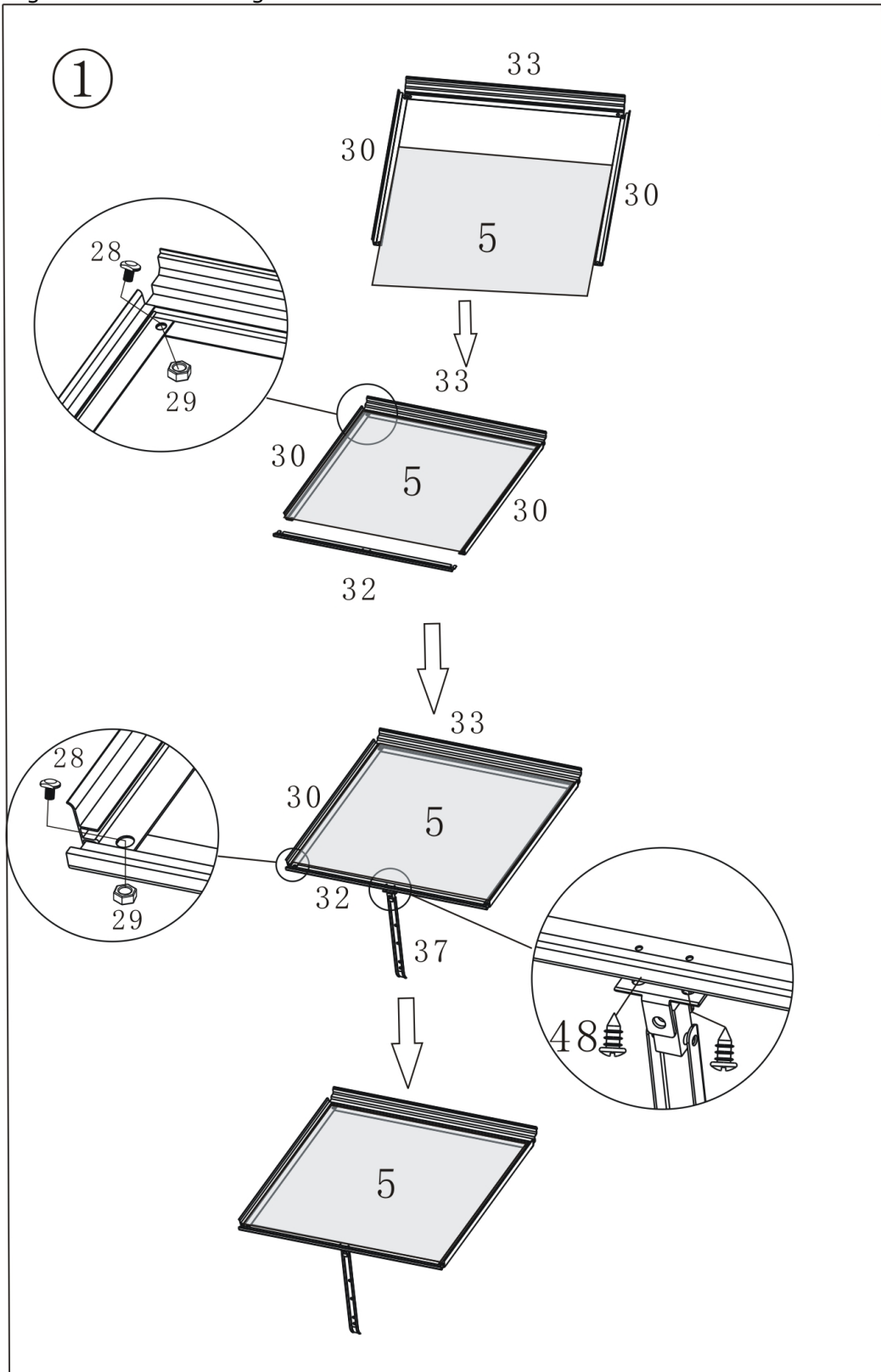

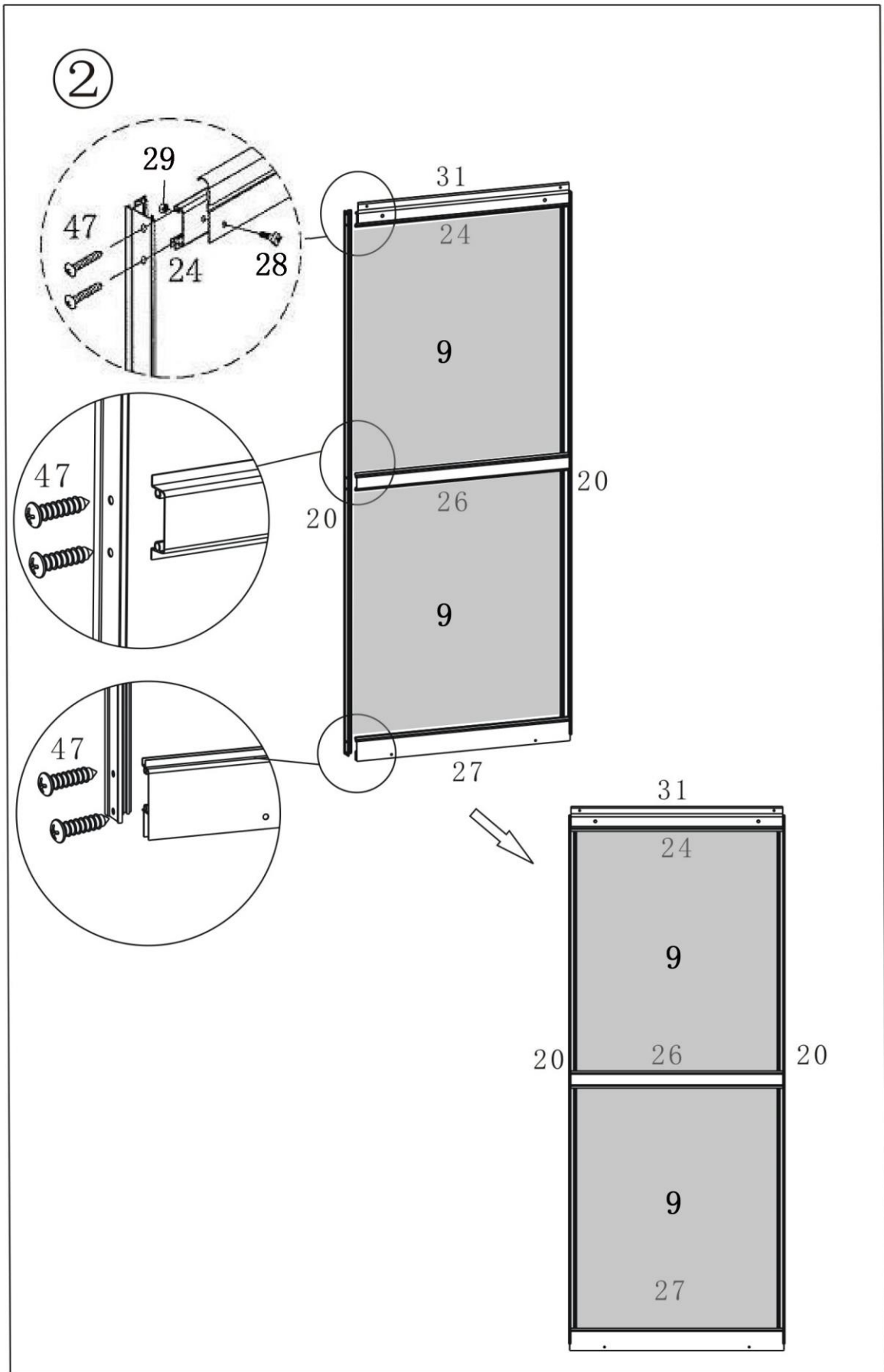

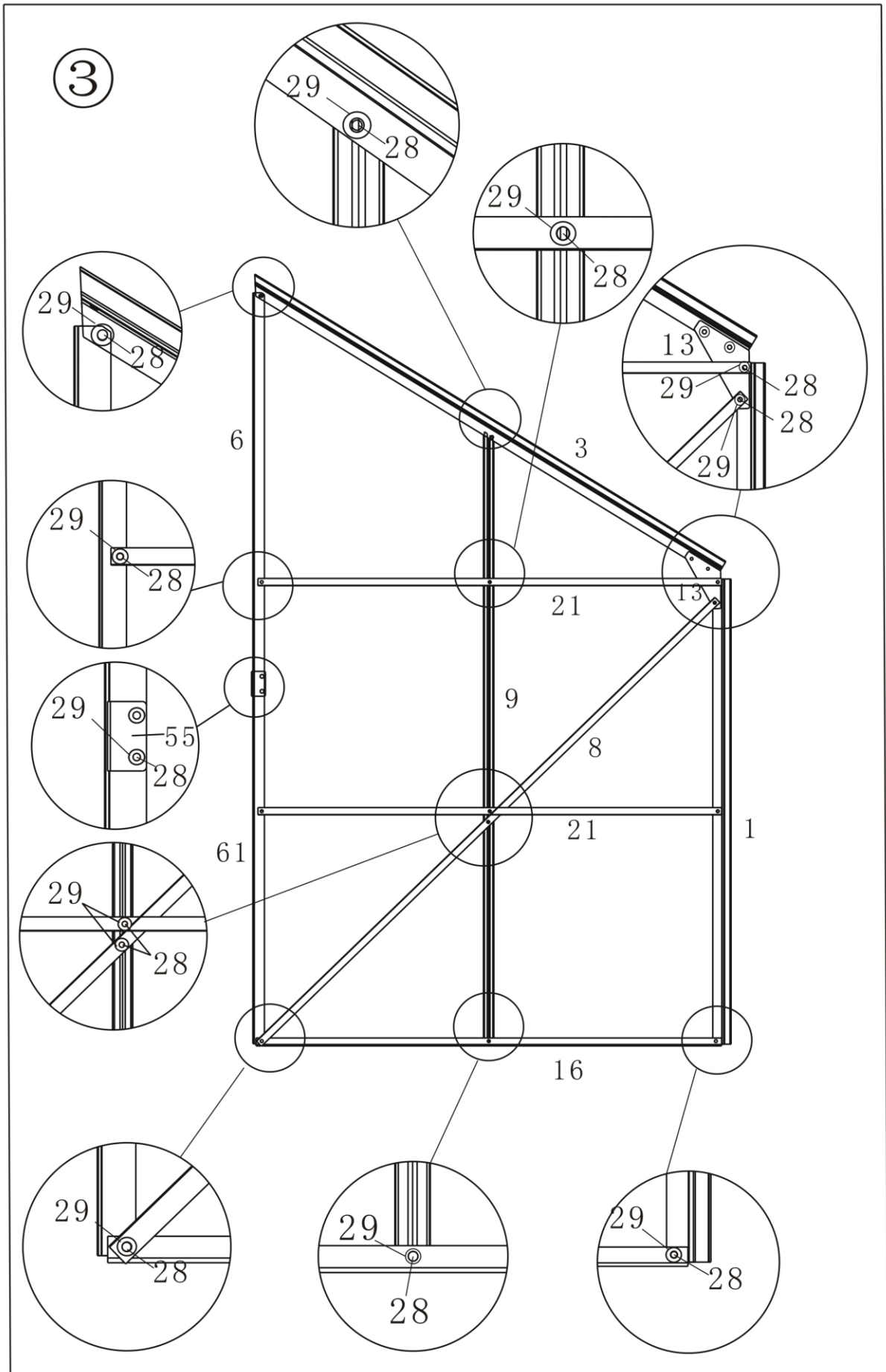

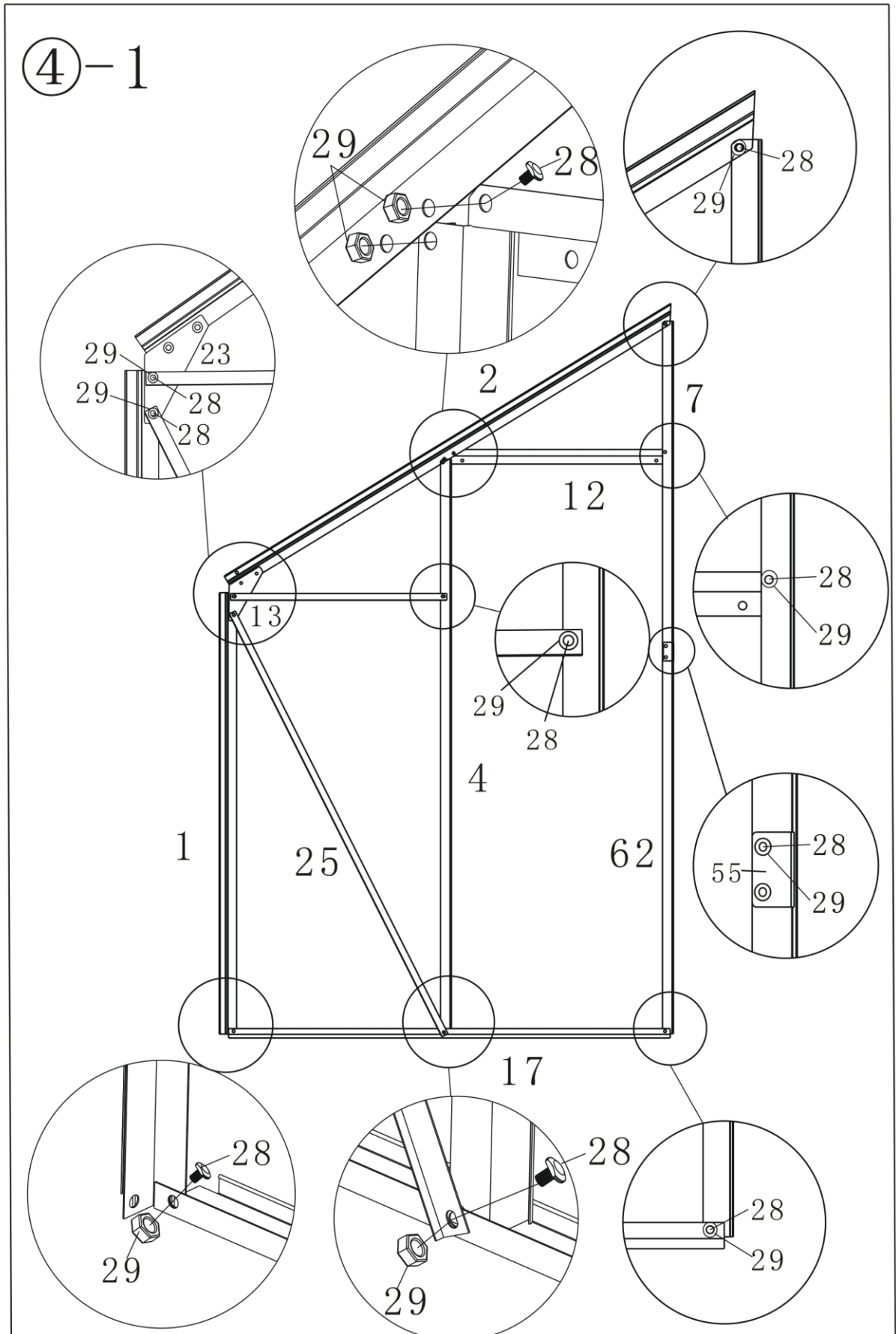

④-2

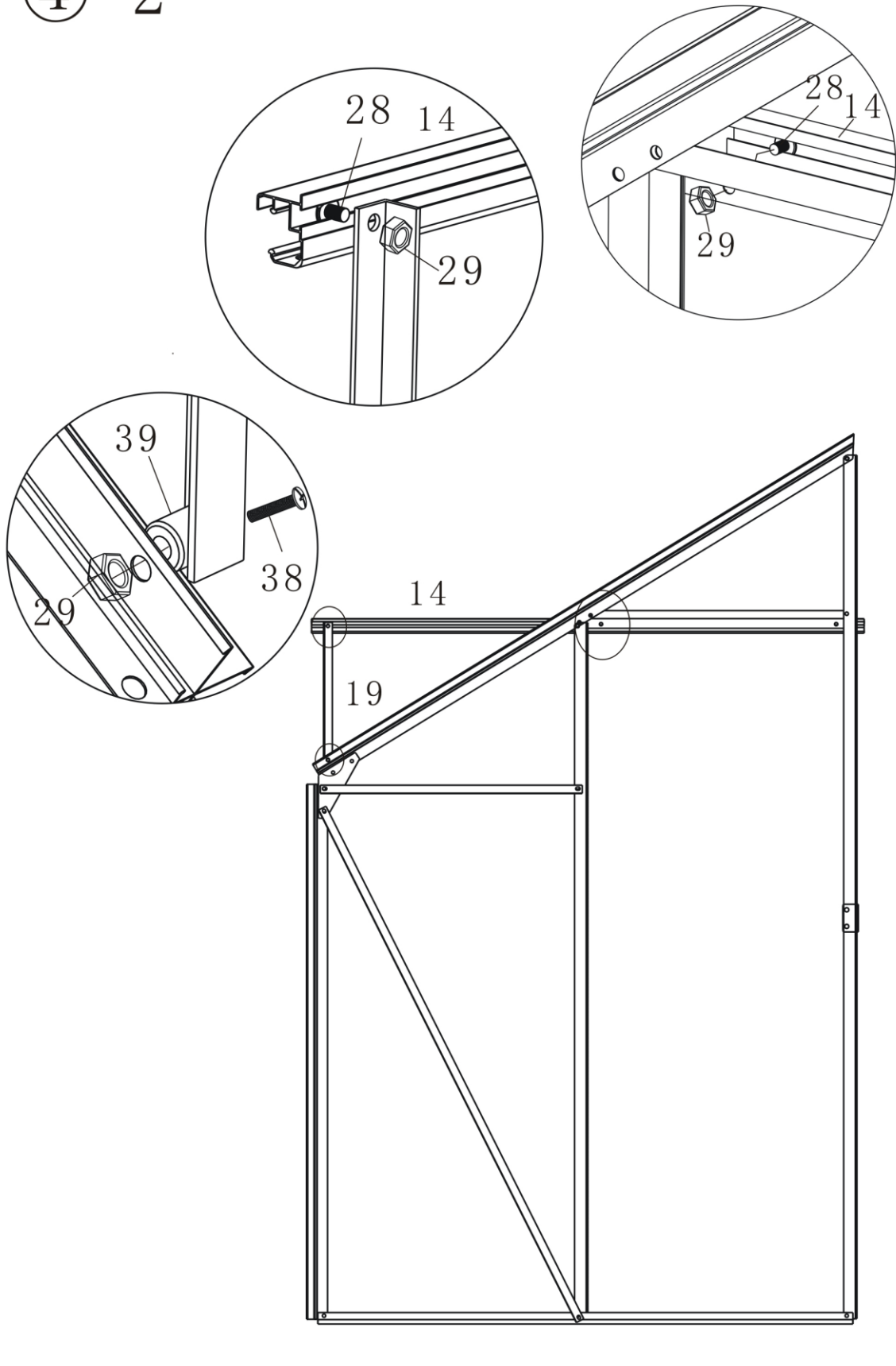

5

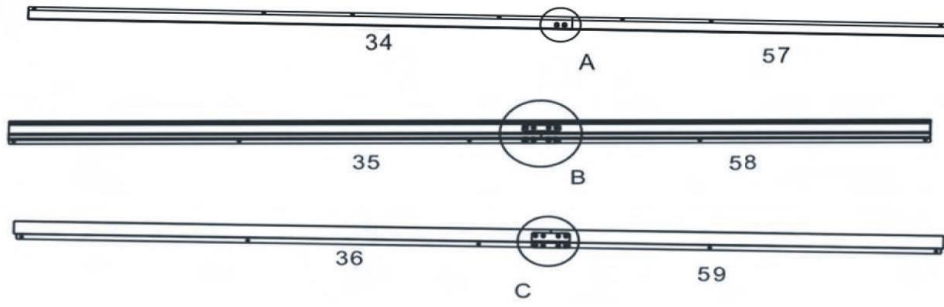

Formteile überlappen => keine Verbindungsplatte notwendig

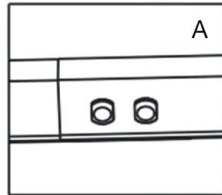

Verbindungsplatte Nr. 51 nur einseitig verwenden

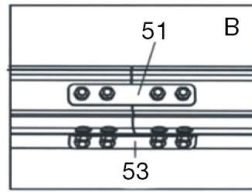

Verbindungsplatte Nr. 51 nur einseitig verwenden

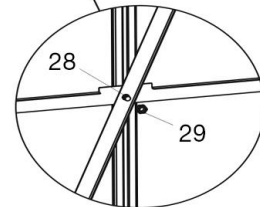
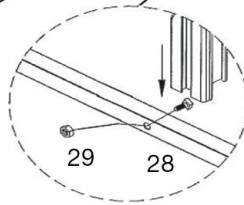
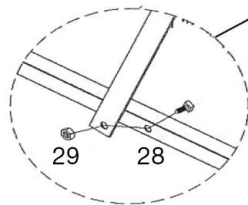
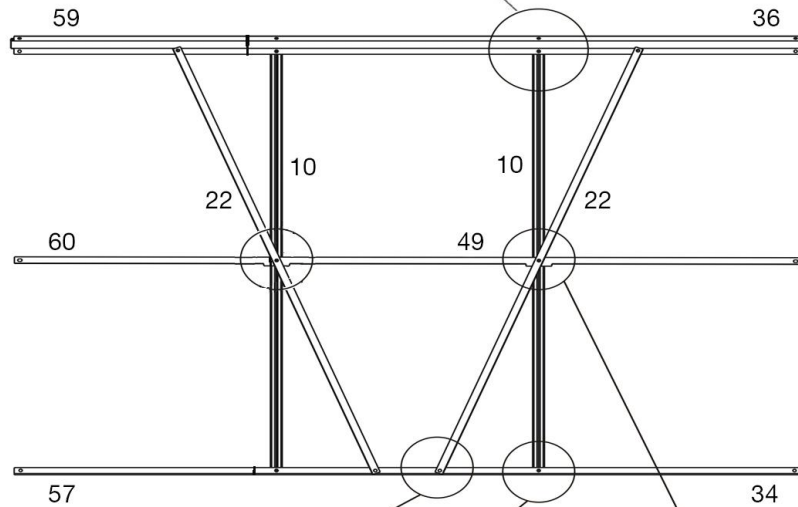
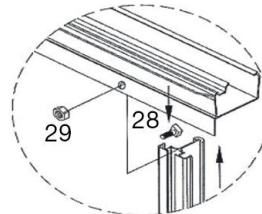
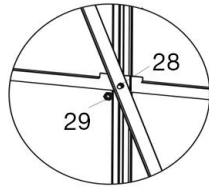
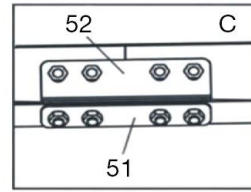

⑥-1

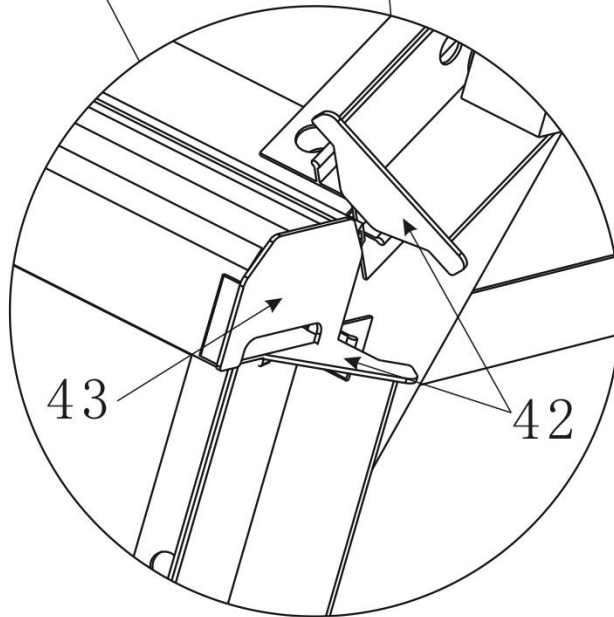
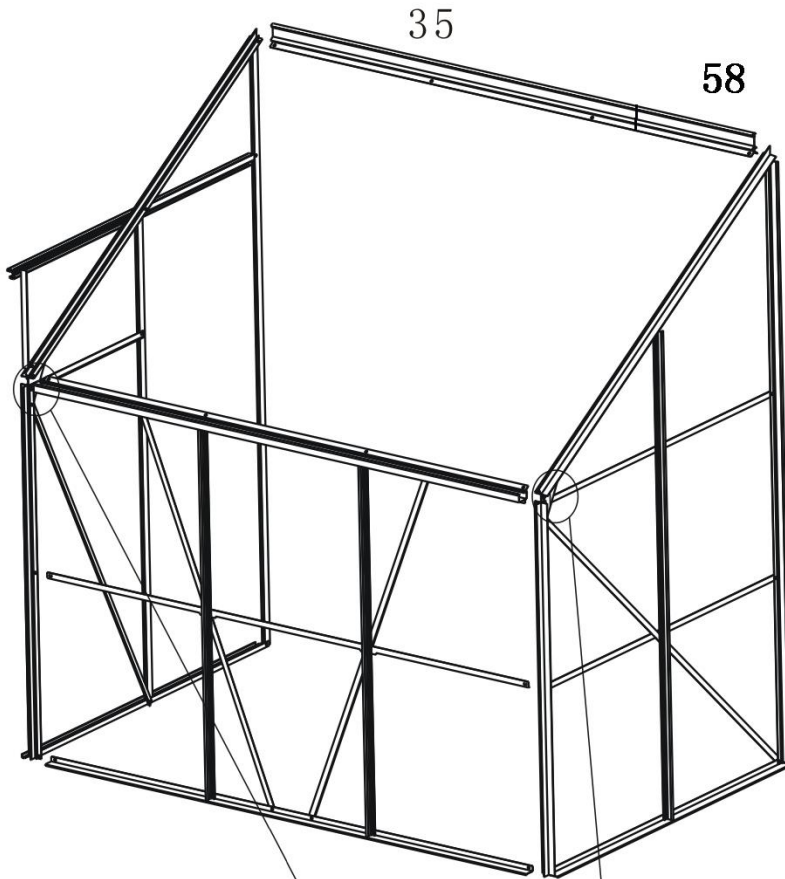

⑥-2

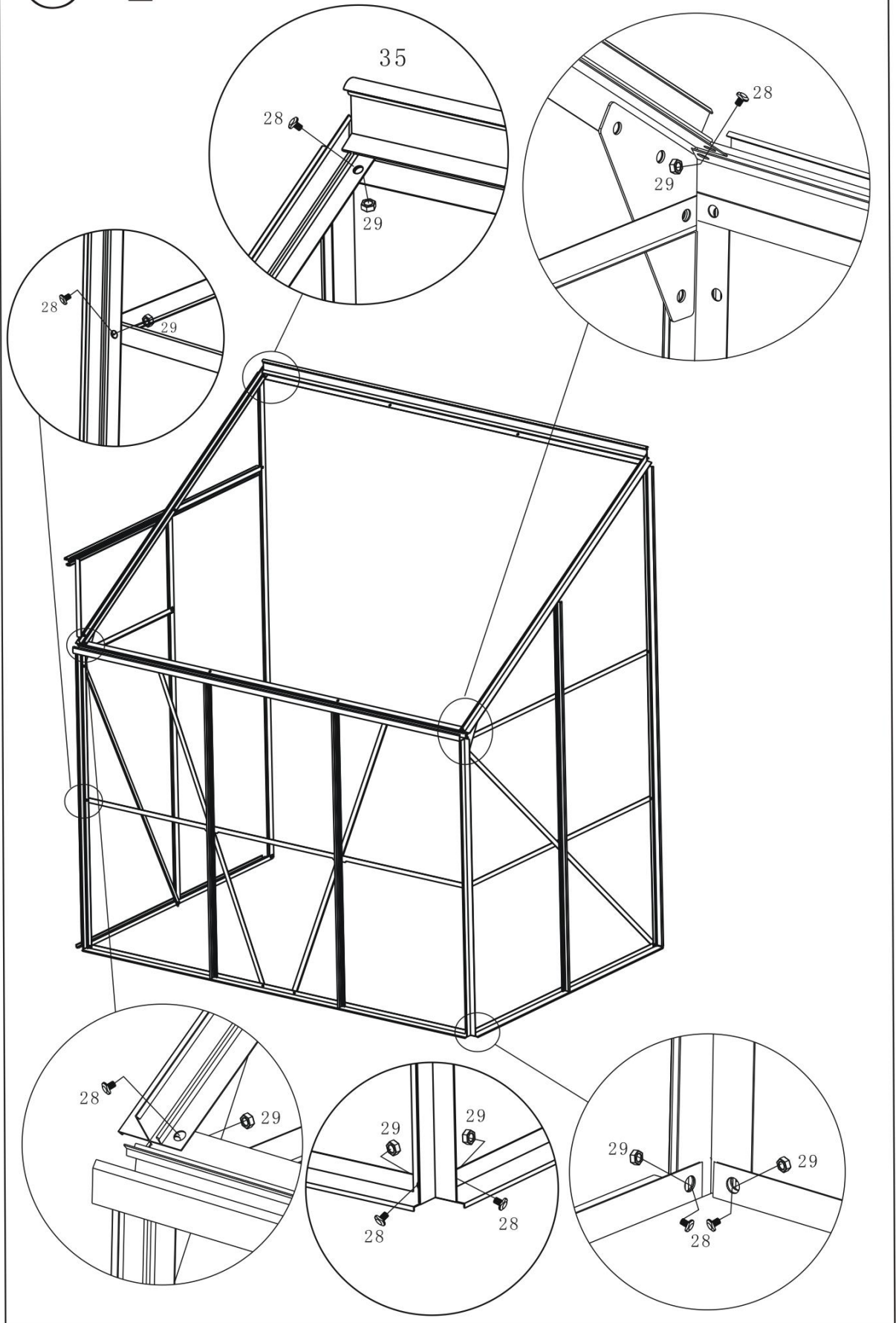

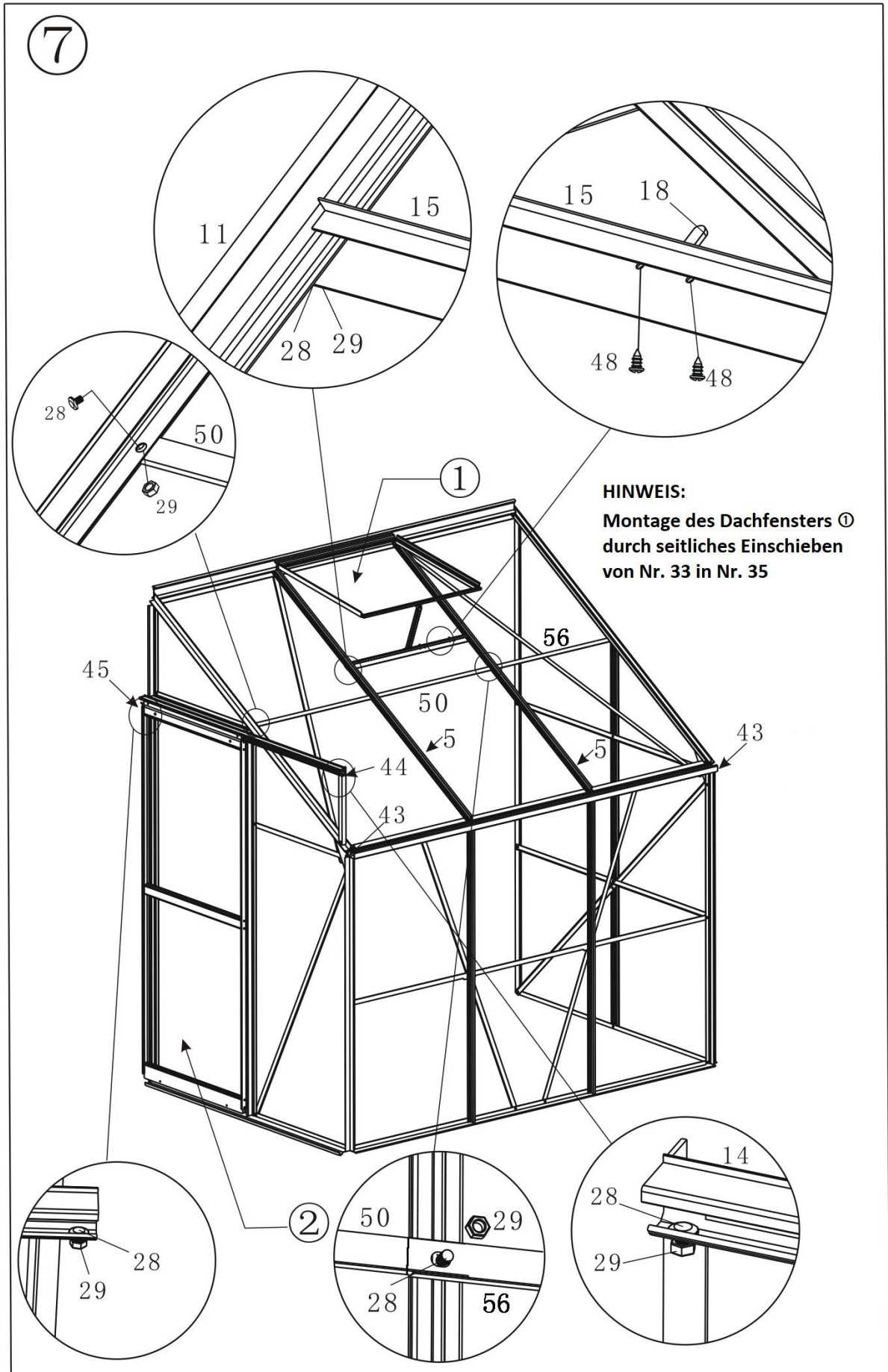

8

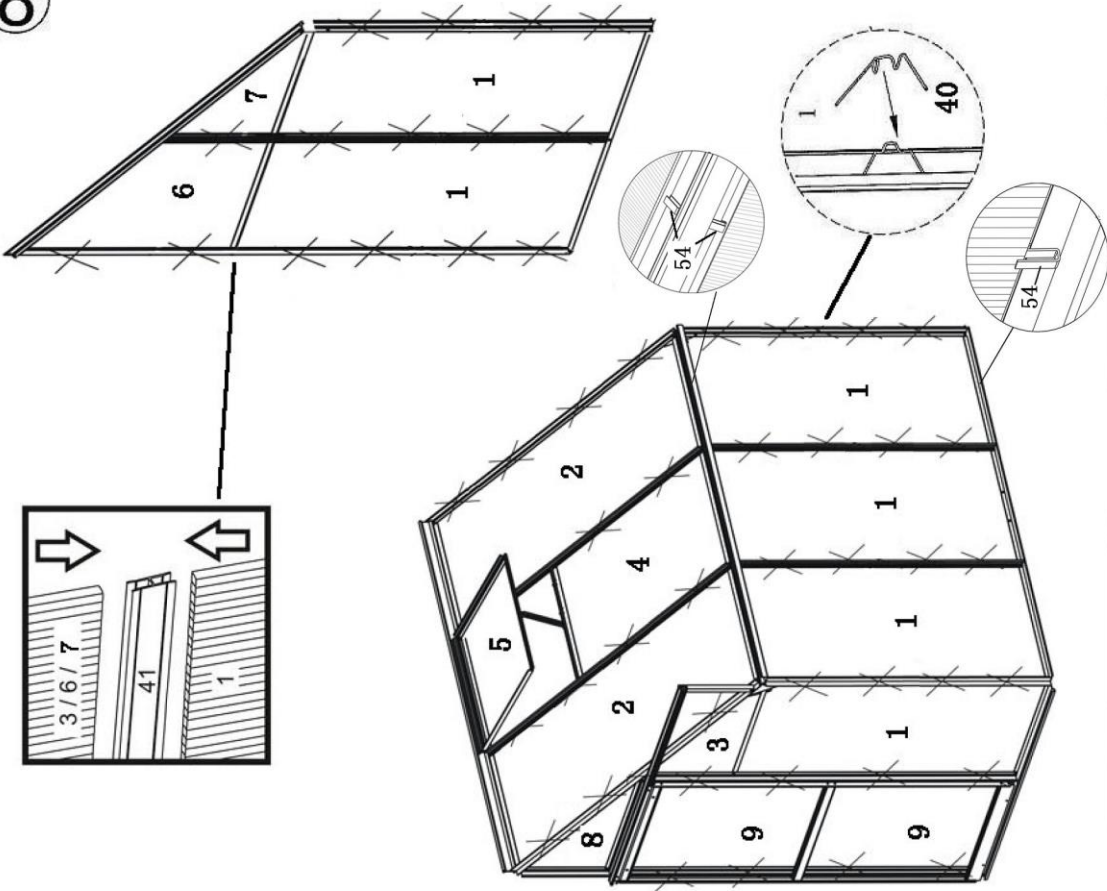

FALSCH





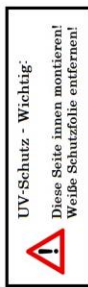





























RICHTIG

Achten Sie auf den Hinweis zum UV-Schutz:











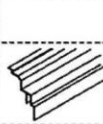

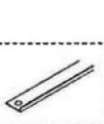

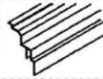

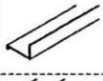

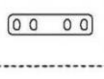
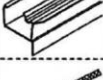
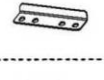

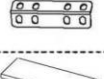
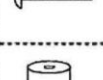
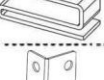
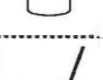
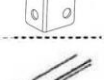

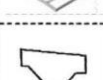
NR	MABE	STK
1	605x1210	6X
2	605x1410	2X
3	605x 25/380	1X
4	605x 875	1X
5	600x549	1X
6	605x 390/745	1X
7	605x 25/380	1X
8	610x 15/370	1X
9	610x 700	2X

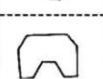

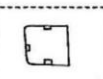
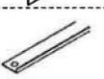
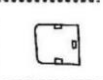
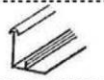
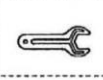
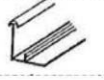
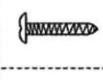



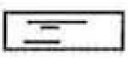
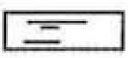

5 TEILELISTE

#		MM	#x	#		MM	#x
1		1214 mm	2x	17		1215 mm	1x
2		1420 mm	1x	18			2x
3		1420 mm	1x	19		320 mm	1x
4		1580 mm	1x	20		1525 mm	2x
5		1520 mm	2x	21		1205 mm	2x
6a		970mm	1x	22		1302 mm	2x
7a		970mm	1x	23		595 mm	1x
8		1665	1x	24		616 mm	1x
9		1600 mm	1x	25		1302 mm	1x
10		1214 mm	2x	26		616 mm	1x
11		1400 mm	2x	27		616 mm	1x
12		599 mm	1x	28		M6x10	107x
13			2x	29		M6 mm	108x
14		1255 mm	1x	30		522 mm	2x
15		635 mm	1x	31		609 mm	1x
16		1215 mm	1x	32		595 mm	1x

47086 – Alu Anlehn-Gewächshaus Antwerpen

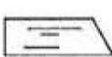
#		 MM	#x	#		 MM	#x
33		598 mm	1x	49a		1235 mm	1x
34a		1350 mm	1x	50a		1235 mm	1x
35a		1350 mm	1x	51			2x
36a		1357.5 mm	1x	52			1x
37			1x	53			1x
38		M6x30 mm	1x	54		22x8x9 mm	12x
39			1x	55			2x
40			96 x	56		625 mm	1x
41		605 mm	3x	57		540 mm	1x
42			4x	58		480 mm	1x
43			2x	59		487.5 mm	1x
44			1x	60		625 mm	1x
45			1x	61		970 mm	1x
46			2x	62		970 mm	1x
47		M4.5x19 mm	12x				
48		M4x7.5	6x				

5-1 PC-GLASSCHEIBEN

#		MM	#x
1		605x1210 mm	6x
2		605x1410 mm	2x
3		605x25/380 mm	1x
4		605x875 mm	1x
5		600x549 mm	1x
6		605x390/745 mm	1x
7		605x25/380 mm	1x
8		610x15/370 mm	1x
9		610x700 mm	2x